

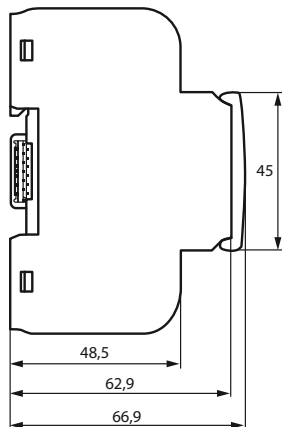

EDS44x...-CN

绝缘故障定位仪 / Insulating fault locator

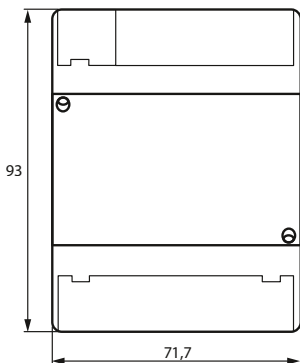

i 这些简要说明适用于以下设备的变体，并不取代手册。

i This quickstart guide applies to the following device variants does not replace the operating manual.

本快速入门指南适用于:

This quick-start guide is valid for:

Type	EDS440(W)-L-CN	EDS440(W)-S-CN	EDS441(W)-L-CN	EDS441(W)-S-CN	EDS441(W)-LAB-CN
Art. No.	B91080202(W)	B91080201(W)	B91080205(W)	B91080204(W)	B91080207(W)
Channel LEDs	x	-	x	-	x
Manual No.	D00201				

使用目的

绝缘故障定位仪 EDS44x 能够定位不接地直流、交流和三相交流系统中的绝缘故障 (IT系统)。

通过故障定位电流发射器 (PGH)，根据PGH的型号来监视交流和三相交流 AC 0...1000V 以及直流 DC 0...1500V 范围的系统。

可以显示 42Hz...1 kHz, 100 mA...20A (EDS440) 或 50/60 Hz...1 kHz, 100 mA...2A (EDS441) 范围内的交流剩余电流。

为了正确操作，必须遵守技术资料中的规范。任何其他使用或超出此范围的使用都被认为是不适当的使用。

i 网络配置、电源电压、电源频率、泄露电容和测试电流会影响 EDS 系统的响应。请参考手册中的响应灵敏度曲线。

Intended use

The insulation fault locator EDS44x locates insulation faults in ungrounded DC, AC and three-phase supplies (IT systems).

With an active test current generator (PGH), AC and three-phase networks in the range AC 0...1000 V and DC networks in the range DC 0...1500 V can, depending on the PGH type, be monitored.

An AC residual current in the range 42 Hz...1 kHz, 100 mA...20 A (EDS440) or 50/60 Hz, 100 mA...2 A (EDS441) can be displayed.

For proper operation, the specification in the technical data must be observed. Any other use or use that goes beyond this is considered improper use.

i Network configuration, mains voltage, mains frequency, leakage capacitance and test current influence the responsiveness of the EDS system. Please refer to the response sensitivity curve in the manual.

安全说明



电击危险!

在安装设备之前，请确保系统是断电的。否则可能会发生电击。此外，电气装置可能会损坏并且设备可能会被损坏无法修复。

i 对于UL应用: 仅使用 60/75 °C 的铜线! 对于 UL 和 CSA 应用，电源电压必须通过 5 A 的保险丝进行保护。

i 被监视网络的最大电压不得大于所有使用中组件的额定绝缘电压。根据技术参数选择电缆和电缆长度。

Safety instructions



DANGER! Electric shock! Make sure the system is de-energized before installing and connecting the device. Otherwise there is a risk of life-threatening electric shock. Furthermore, the electrical installation may be damaged and the device may be destroyed beyond repair. .)

i For UL applications: Use 60/75 °C copper wires only! For UL and CSA applications, the supply voltage must be protected via 5 A fuses.

i The maximum voltage of the monitored network must not be greater than the rated insulation voltage of all components used. Select cables and cable lengths according to the technical data.

Montage

DIN导轨安装 / DIN rail mounting



Mounting

螺丝安装 /Screw mounting

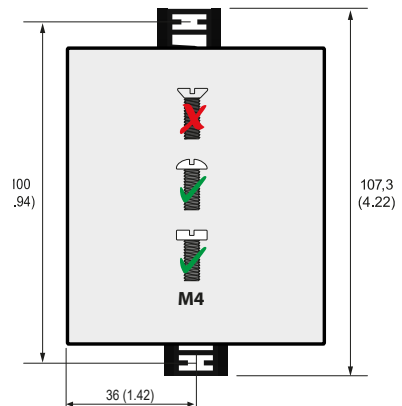

DIN导轨安装

将所有提供的设备安装夹扣在底部的顶帽导轨上，以确保安全和紧密的配合。

螺丝安装

手动或通过工具将提供的安装夹子移到突出于外壳的卡入位置。用两个M4螺钉固定设备。

DIN rail mounting

Snap all mounting clips delivered with the device onto the DIN rail in such a way that a safe and tight fit is ensured.

Screw mounting

Install the accompanying mounting clips manually or by means of a tool in a way that they protrude beyond the enclosure. Fix the device by means of two M4 screws.

连接

参考接线图连接设备。同时也请参考技术参数。

在连接设备之后，安装上下盖板。

Connection

Wire up the device according to the wiring diagram taking account of the technical data. After connecting the device, install the enclosed upper and lower terminal cover.

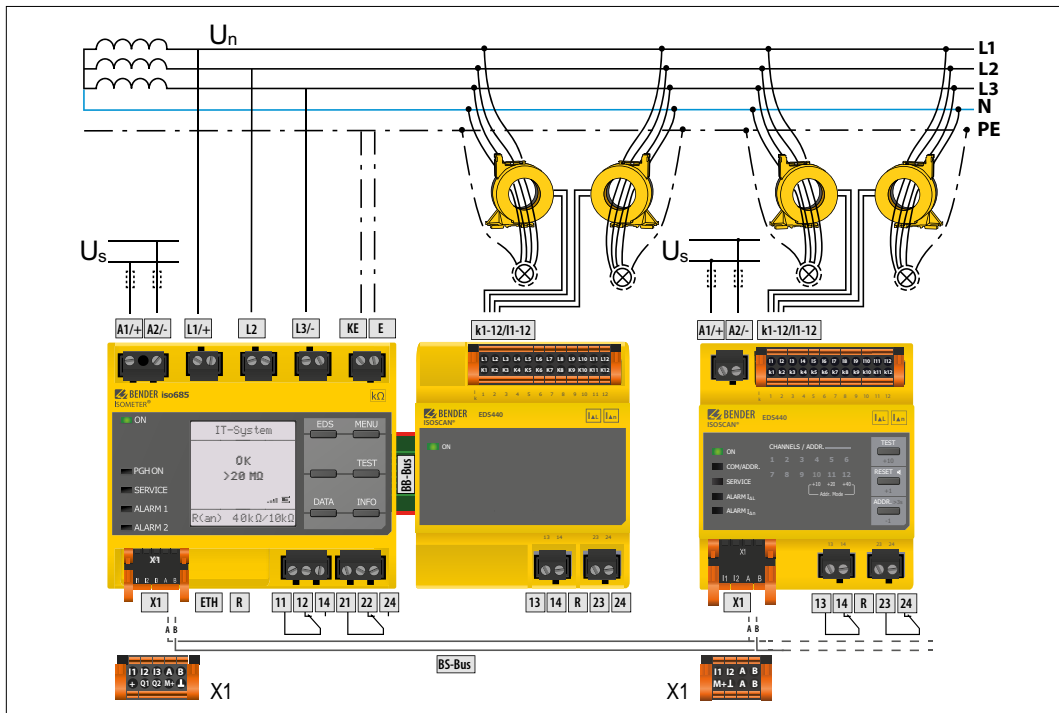

接线图例

Klemme	Anschlüsse EDS44x
A1/+, A2/- **	连接到电源电压, $U_s = AC/DS 24...240 V (50...400Hz)$
k1-12/I1-12	连接测量电流互感器
I1, I2 (X1)	可配置数字输入 (例如, 测试, 重置)
A, B (X1)	串行接口 RS-485 (BS总线)
(X1)	可配置的模拟输出
M+ (X1)	可配置的数字电流输出 0或20 mA, 例如, 用于 PLC 电流输入
13-14 23-24	报警继电器 可选不同的功能
R	终端电阻器来终止 RS-485接口 (BS总线)
BB-Bus	Bender 产品的通讯接口

Legend to terminal diagrams

Terminal	Connections
A1/+ A2/- **	Power supply, $U_s = AC/DC 24...240 V (50...400 Hz)$
k1-12/I1-12	Measuring current transformer connection
I1, I2 (X1)	Configurable digital inputs (e.g. Test, Reset)
A, B (X1)	Serial interface RS-485 (BS bus)
(X1)	Reference potential ground
M+ (X1)	Configurable digital current output 0 or 20 mA, e.g. for PLC current input
13-14 23-24	Alarm relay Different functions can be selected
R	Termination of the RS-485 interface (BS bus)
BB-Bus	Communications interface for Bender products

i ** 提供线路保护!
符合标准 DIN VDE 0100-430, 线路保护将用于电源电压。

i ** Provide line protection! Acc. to DIN VDE 0100-430, a line protection shall be provided for the supply voltage

转换器连接

Transducer connection

CTAC, WR, WS

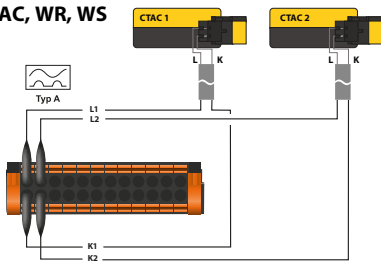

CTAF

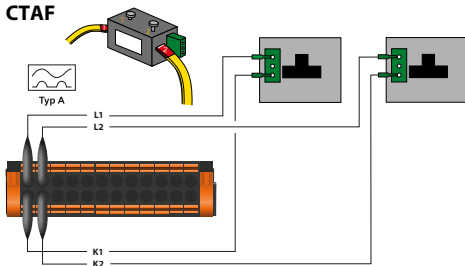

CTUB104

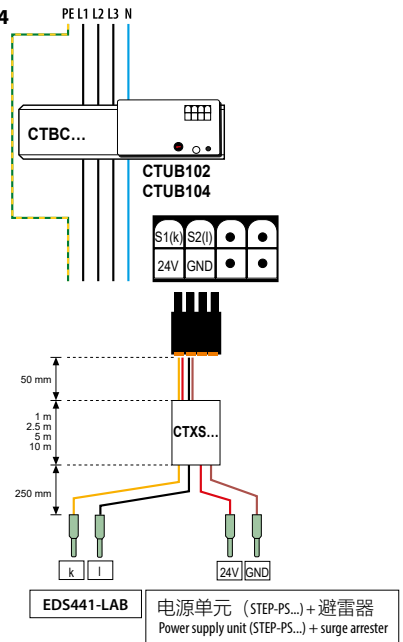

设备的启动

首次启动之前

1. PE 线没有通过测量电流互感器传导。
2. 在电流互感器周围没有干扰磁场。
3. 最大允许电缆长度符合测量电流互感器的长度的要求。
4. 在 BS 总线的首尾两端终止，例如：R (= ON)。
5. 在总线系统 (21) 中，BS 总线电缆所允许的长度 (最大1200 m)
6. 以及 EDS44x 设备的数量不能超过。
7. 一个地址不能被分配 2 次。

首次启动

1. 连接设备和电流互感器。
2. 通过 BS 总线 (EDS44x-L-CN) 或 BB 总线 (EDS44x-S-CN) 互相连接设备。
3. 打开电源电压。LED灯“ON”在通电后闪烁，直到设备准备就绪。
4. 设置适合的 BS 总线地址。
5. EDS44x-L-CN: 通过使用 EDS 旋转开关。通过亮着的 LED 灯指示选择的通道地址。
6. 通过 ISOMETER® 或 EDS44x-L-CN 重置按钮消除所有可能显示的绝缘和设备故障。
7. 确保 EDS44x 是正确连接的。
8. 互感器连接测试每10分钟执行一次。在每个测试期间，“ON”LED灯闪烁。

参考 ISOMETER® 手册，启动 ISOMETER® 和来自 EDS44x 和 ISOMETER® 的系统。

Commissioning of the device

Prior to initial commissioning following Aspects

1. Do not lead PE conductors through a measuring current transformer.
2. Avoid disturbing magnetic fields in the vicinity of the measuring current transformers.
3. The maximum permissible cable length to the measuring current transformers must be observed.
4. The beginning and end of the BS bus must be terminated. Terminating resistor R (=ON).
5. The maximum permissible length of the BS bus cable is 1200 metres.
6. The maximum number of EDS44x in the bus system must not be exceeded. (see manual)
7. An address is not assigned twice.

Initial commissioning

1. Connect the device and the current transformer.
2. Connect the devices to each other via the BS bus (EDS44x-L) or BB-Bus (EDS44x-S).
3. Switch the supply voltage on. The LED “ON” flashes during power up until the device is ready for operation.
4. Set the appropriate BS bus address.
5. The selected channel address is indicated by a lighting LED.
6. Eliminate all possible displayed insulation and device faults via the ISOMETER® or the EDS44x-L RESET button.
7. Ensure the EDS44x is properly connected.
8. A transformer connection test is carried out every 60 minutes. During each test, the “ON” LED flashes.

To commission the ISOMETER® and the system from the EDS44x and ISOMETER®, refer to the documentation of the ISOMETER®.

工作

ED44x-S-CN 只能通 ISOMETER® 行操作。

ED44x-L-CN 可以通 下列三个按 以及 ISOMETER® 行操作。

Operation

The EDS44x-S can only be operated via the ISOMETER®.

The EDS44x-L is operated via the three keys and otherwise via the ISOMETER®

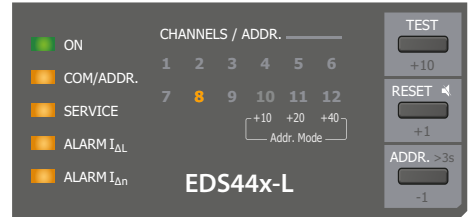

钥匙	职能
TEST	触发自我测试
RESET	按 1×: 停用蜂鸣器 按 2×: 重置故障存储器
ADDR.	读出并设置 BS 地址
RESET + ADDR.	0,5 s: 显示当前的显示协议 3 s: 传输协议之间的变化

Key	Functions
TEST	Initiate self test
RESET	Press 1 x: Deactivate buzzer Press 2 x: Reset fault memory
ADDR.	Set BS address
RESET + ADDR.	0.5 s: Display of the current display protocol 3 s: Change of transmission protocols

LED	描述
ON	LED 闪烁: 设备尚未准备好进行操作或正在进行测试。 LED 灯亮起: 设备已准备好进行操作。
COM/ ADDR:	当设备通过 RS-485 接口进行通信时, LED 灯快速闪烁。
SERVICE	当出现设备故障、传感器连接故障或故障信息时 LED 灯亮起。
ALARM I _{dl}	LED 发出主要警报的信号。
ALARM I _{dn}	当超过残余电流的设定响应值时, LED 灯亮起。
CHANNELS /ADDR 1...12	LED 灯亮了。在相应的测量通道中发现了一个绝缘故障。 LED 灯闪烁。 - 缓慢 (1 赫兹): 连接错误 - 快速 (2 赫兹): 故障
ADDR. Mode	显示通道的当前十进制计数器 LED 10, 11, 12

LED	Description
ON	LED flashes: The device is not yet ready for operation or a test is being performed. LED lights up: The device is ready for operation.
COM/ ADDR:	The LED flashes quickly when the device is communicating via the RS-485 interface.
SERVICE	The LED lights up when there is a device error, a transducer connection error or a fault message.
ALARM I _{dl}	The LED signals the main alarm.
ALARM I _{dn}	The LED lights up when the set response value for differential currents has been exceeded.
CHANNELS /ADDR 1...12	The LEDs light up: An insulation fault has been found in the respective measuring channel. The LEDs flash: - slowly (1 Hz): Connection error - fast (2 Hz): Fault
ADDR. Mode	Display of the current tens counter of the channel LEDs 10, 11, 12

报警和它的作用

报警信息的通用排序

- 如果需要，ISOMETER® 显示故障，测量值或通道。

仅用于EDS44x-L:

- 相应的 LED 灯亮或者闪烁。
- 如果启动，蜂鸣器的声音是断断续续的。
- 分配的报警继电器动作 (EDS44x-X-CN)。
- 分配的数字输出动作。
- 然后报警信息通过BB总线 (EDS44x-S-CN) 或 BS 总线 (EDS44x-L-CN) 发送。

报警信息(EDS44x-S-CN)

- EDS44x-S-CN 报警系统通过继电器报告并且通过 ISOMETER® 显示。

报警信息(EDS44x-L)

- 绝缘故障: LED „ALARM IΔL“ (主报警) 和测量通道 LED 灯所对应的灯同时亮起, 就可找到对应的错误。
- 如果超过剩余电流阈值: LED „ALARM IΔn“ 和测量通道 LED 灯所对应的灯同时亮起, 就可找到对应的错误。
- 设备故障, 互感器连接故障: „SERVICE“ LED灯亮。此外, 相应通道的 LED 灯闪烁。
- 报警信息: 受影响的测量通道的通道 LED 闪烁。
- 如果几个错误信息同时输出, 单独信息可以通过观察报警或服务 LED 灯或闪烁的通道 LED 来区分。

声音报警(蜂鸣器) 可以被分配用于下列故障信息并且用过 RESET (静音) 按钮停用。Alarm IΔL、Alarm IΔn、设备故障、连接故障、普通报警、主动绝缘故障定位

重置报警信息 (RESET)

- 要求: 重置故障记忆, 同时故障不再存在。
 - 执行 RESET 来重置报警。有3中可能性:
 - 按下 EDS44x-L-CN 的 RESET 的按钮持续至少1秒。
 - 按下外部重置按钮连接到 EDS44x
 - 在 BS 总线或 BB 总线上, 从 ISOMETER® 发送 RESET 命令。
- 按下 ISOMETER® 上的“ESC”按钮 退出当前警告信息的显示。

Alarm and its effect

General sequence of an alarm message

- The ISOMETER® display indicates a fault and, if applicable, a measured value or channel.

EDS44x-L only:

- The corresponding LEDs light or flash.
- The buzzer sounds intermittently if activated.
- Assigned alarm relays will switch (EDS44x-X).
- Assigned digital outputs will switch.
- An alarm message is then sent over the BB bus (EDS44x-S-CN) or BS bus (EDS44x-L-CN).

Alarm messages (EDS44x-S)

- EDS44x-S alarm messages are reported via the relays and are displayed via the ISOMETER®.

Alarm messages (EDS44x-L)

- Insulation fault: Both the LED “ALARM IΔL” (main alarm) and the measuring channel LED, corresponding to where the error was found, light.
- If the residual current threshold is exceeded: Both the LED “ALARM IΔn” and the measuring channel LED, corresponding to where the error was found, light.
- Device fault, transformer connection fault: The “SERVICE” LED lights. In addition, the corresponding channel LED flashes.
- Alarm messages: The channel LED of the affected measuring channel flashes.
- If several error messages are simultaneously output, individual messages can be distinguished by observing which alarm or service LED lights or flashes with which channel LED.

The audible alarm (buzzer) can be assigned the following error messages and deactivated with the “RESET” button: Alarm IΔL, Alarm IΔn, device fault, connection fault, common alarm, active insulation fault location.

Reset alarm messages (RESET)

Requirement: The fault memory has been activated and the error is no longer active.

- Execute a RESET to reset the alarms. There are 3 possibilities:
 - Press the EDS44x-L “RESET” button for at least 1s.
 - Press an external RESET button connected to the EDS44x
 - Transmit a RESET command from an ISOMETER® over the BS bus or BB bus.
- Press the “ESC” button on the ISOMETER® to exit the display of the current alarm message.

技术参数

绝缘协调性 (IEC 60664-1/IEC 60664-3)

额定电压	AC 250 V
额定脉冲电压 (IEC 60664-1)	4 kV
过电压分类 (OVC)	III

电源电压

电源电压范围 U_s	AC/DC 24...240 V
频率范围 U_s	DC, 50...400 Hz

响应值

绝缘故障定位响应值 ($I_{\Delta I}$)

EDS440:	1.5...25 mA (DC 50 mA)
EDS441:	0.15...5 mA
额定频率范围	DC, $16^{2/3}$...1000 Hz

剩余电流测量响应值 ($I_{\Delta n}$)

EDS440:	100 mA...10 A (50...1000 Hz)
EDS441:	100 mA...1 A (50...60 Hz)

接口

接口/协议	RS-485/BS
-------------	-----------

周期

额定工作电压	250 VAC
额定工作电流	7 A
额定绝缘电压	4 kV

接触数据符合 IEC 60947-5-1 标准

使用类别	AC-13/AC-14/DC-12/DC-12/DC-12/DC-12
额定操作电压	230 V/230 V/24 V/48 V/110 V/220 V
额定操作电流	5 A/3 A/1 A/1 A/0.2 A/0.1 A
额定绝缘电压 ≤ 2000 m NN	250 V
额定绝缘电压 ≤ 3000 m NN	160 V
交流/直流电时的最小额定接触电流	1 mA at AC/DC ≥ 10 V

其它

EMC	IEC 61326-2-4
防护等级、内置元件 (DIN EN 60529)	IP40
防护等级、端子 (DIN EN 60529)	IP20

Technical data

Insulation co-ordination (IEC 60664-1/IEC 60664-3)

Rated voltage	AC 250 V
Overvoltage category (OVC)	III
Rated impulse voltage (IEC 60664-1)	4 kV

Supply voltage

Supply voltage U_s	AC/DC 24...240 V
Frequency range from U_s	DC, 50...400 Hz

Measuring ranges

Insulation fault location measurement range ($I_{\Delta I}$)

EDS440:	1.5...25 mA (DC, 50 mA)
EDS441:	0.15...5 mA
Rated frequency range	DC, $16^{2/3}$...1000 Hz

Residual current measurement range ($I_{\Delta n}$)

EDS440:	100 mA...20 A, (50...1000 Hz)
EDS441:	100 mA...2 A, (50...60 Hz)

Interfaces

Interface/protocol	RS-485/BS/ Modbus RTU
--------------------------	-----------------------

Switching elements

Rated operating voltage	250 VAC
Rated operational current	7 A
Rated insulation voltage	4 kV

Contact data acc. to IEC 60947-5-1

Utilisation category	AC-13/AC-14/DC-12/DC-12/DC-12/DC-12
Rated op. voltage	230 V/230 V/24 V/48 V/110 V/220 V
Rated op. current	5 A/3 A/1 A/1 A/0.2 A/0.1 A
Rated insulation voltage ≤ 2000 m NN	250 V
Rated insulation voltage ≤ 3000 m NN	160 V
Minimum contact rating	1 mA at AC/DC ≥ 10 V

Other

EMC	IEC 61326-2-4
Degree of protection, built-in components (DIN EN 60529)	IP40
Degree of protection, terminals (DIN EN 60529)	IP20



Bender GmbH & Co. KG

Londorfer Straße 65
35305 Grünberg
Germany

电话 / Tel.: +49 6401 807-0
电子邮件 / E-Mail: info@bender.de
www.bender.de

保留版权。
复制和转载
必须由出版商认可。

All rights reserved.
Reprinting and duplicating only with
permission of the publisher.



© Bender GmbH & Co. KG, Germany
Subject to change! The specified
standards take into account the edition
valid until 11/2023 unless otherwise
indicated.